

12V C.C. - D.C.

VA11-AP7/C-29A
VA11-AP7/C-29S

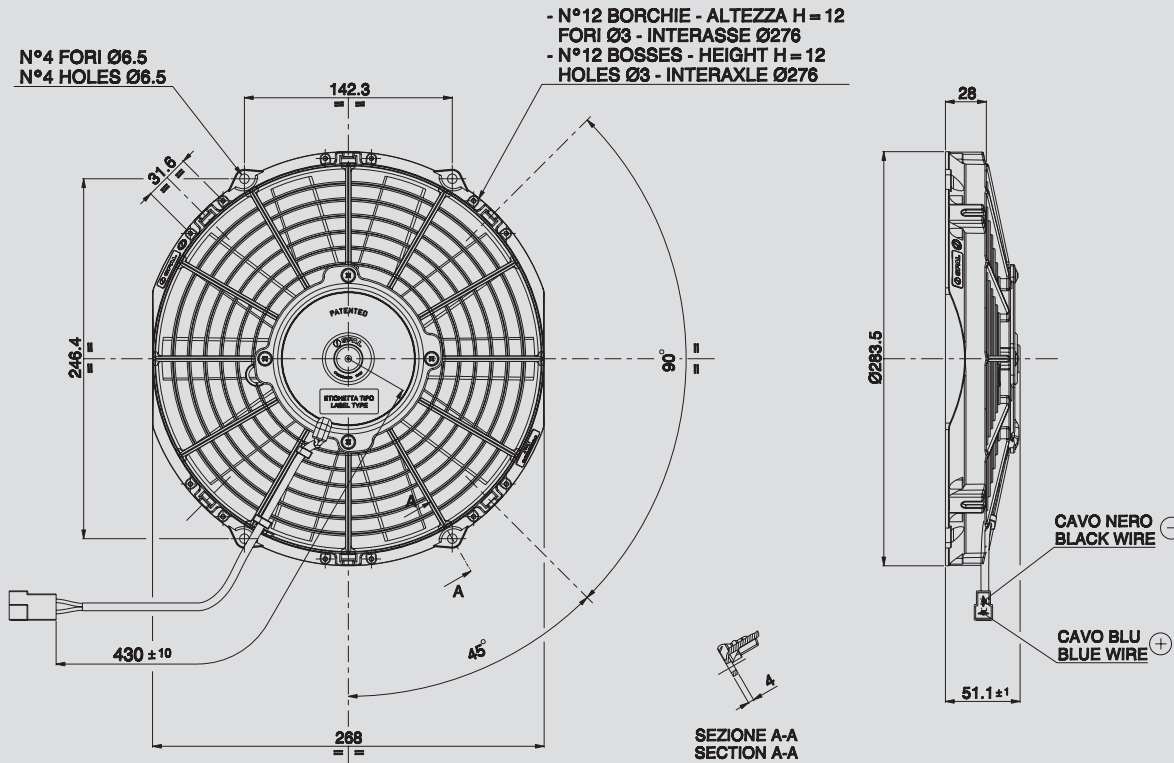

AMP connector Code 180908
AMP terminal Code 42098-2
Suggested mounting torque: 3(+1/-0) Nm with screw M5
Weight 1,00 Kg. approx.

Connettore AMP Cod. 180908
Terminali AMP Cod. 42098-2
Coppia di serraggio consigliata: 3(+1/-0) Nm con vite M5
Peso 1,00 Kg. circa

Ø 255 mm

Ø 10"

suction / aspirante

blowing / soffiante

PRODUCT FEATURES
CARATTERISTICHE PRODOTTO

Static pressure Pressione statica mm H ₂ O	suction / aspirante			blowing / soffiante			Static pressure Pressione statica in H ₂ O
	Airflow Portata m ³ /h	Current input Corrente assorbita A	Airflow Portata CFM	Airflow Portata m ³ /h	Current input Corrente assorbita A	Airflow Portata CFM	
0	1250	9,0	738	1270	8,6	749	0
2,5	1140	9,1	673	1180	8,8	696	0,1
5	1060	9,4	625	1090	9,0	643	0,2
7,5	950	9,4	561	970	9,0	572	0,3
10	780	9,4	460	800	9,1	472	0,4
12,5	610	9,3	360	640	9,4	378	0,5
15	460	9,4	271	410	9,3	242	0,6
17,5	310	9,7	183	290	9,2	171	0,7
20	230	9,6	136	70	9,1	41	0,8
25	0	9,7	0	0	9,1	0	1

Waterproof motor, IP 68 Motore chiuso, IP 68	✓
Long life / Lunga durata	✓
LL and VLL version* Versione LL e VLL*	✓
Waterproof connector Connettori a tenuta stagna	✓
Accessories: all the fixing kits Accessori: tutti i kit di fissaggio	✓

* for OEM applications only.
* per applicazioni OEM

✓ = Standard feature
Caratteristiche standard
✓ = Available upon request
Disponibile su richiesta

Test voltage 13 V. d.c. - Tensione di prova 13 V. c.c.